

Gas Spring End Fittings

DICTATOR gas springs are available with a variety of fittings to allow for optimal installation.

When selecting end fittings it is important to remember that **gas springs must never be mounted rigidly**.

We have listed the available end fittings with the respective gas springs. On the following pages you will find all measurements for these end fittings, as well as those for a few extra end fittings. Please contact us if you would need or prefer other end fitting models.

Apart from a few exceptions the dimensions of the end fittings in AISI 303 and 316L are identical with those in steel or aluminium.

The eyelet on gas springs with **A-A end fittings is pressed into the cylinder**. Therefore measurement D of this eyelet is shorter than that of the eyelet that is screwed onto the piston rod. Should you require eyelets to be screwed onto both ends, please order the eyelet on the cylinder as „GZA“.

All other **end fittings are screwed** onto the thread of either the piston rod or cylinder.

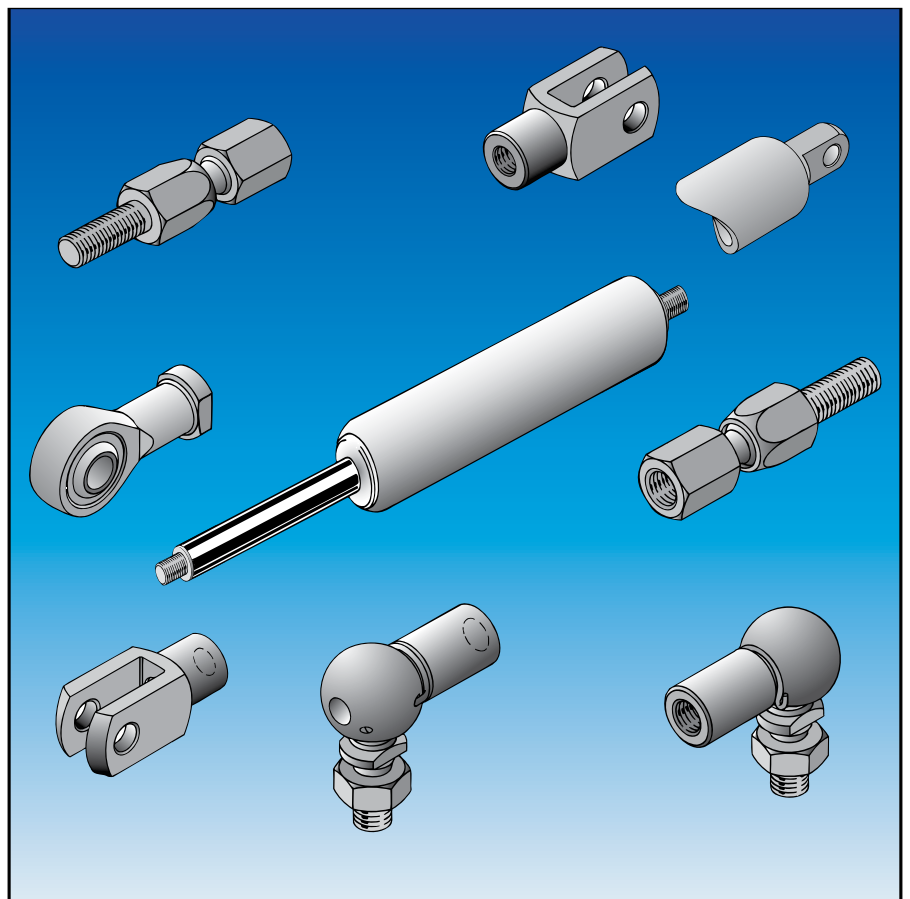

Technical Data

Material	steel, aluminium, AISI 303, 316L
	AISI 303 = 1.4305
	AISI 316L = 1.4404
Maximum force allowed	see information pages on gas springs

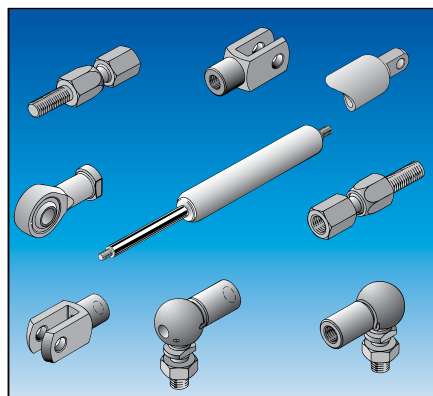

Gas Spring End Fittings Dimensioned Drawings

There is a multitude of end fittings for DICTATOR gas springs, but the most frequently used end fitting is the eyelet. We also offer mounting devices for this end fitting.

If you order a gas spring with an A-A end fitting it usually comes with the eyelet pressed into the cylinder. (Please see details concerning individual types of gas springs). However, if you need a gas spring with an eyelet screwed onto both ends, please order the gas spring with the **GZA** end fitting on the cylinder.

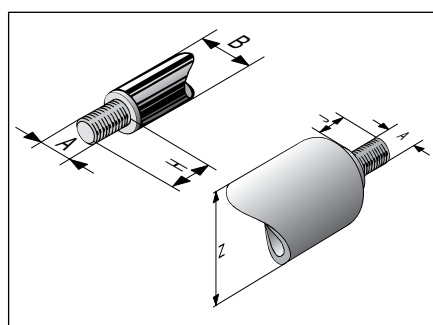

Threaded end (GZ)

	3-10	4-12	6-15	8-19	10-23	14-28	20-40	25-55	30-65
A	M3,5	M3,5	M5	M8	M8	M10	M14x1,5	M 20x1,5	M24x2
B	Ø3	Ø4	Ø6	Ø8	Ø10	Ø14	Ø20	Ø25	Ø30
H + J	5	5	8	12	12	12	15	30	40
Z	Ø10	Ø12	Ø15	Ø19	Ø23	Ø28	Ø40	Ø55	Ø65

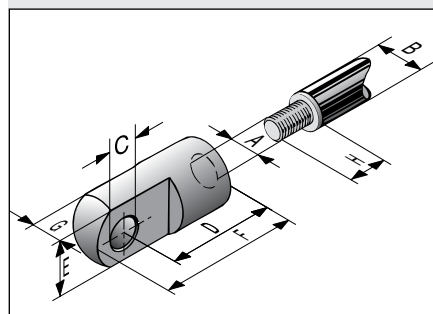

Eyelet with inner-thread for the piston rod (A) - to be screwed on

	3-10	4-12	6-15	8-19	10-23	14-28	20-40
A	M3,5	M3,5	M5	M8	M8	M10	M14x1,5
B	Ø3	Ø4	Ø6	Ø8	Ø10	Ø14	Ø20
C	Ø4,1	Ø4,1	Ø6	Ø8	Ø8	Ø8	Ø14
D	11	11	16	22	22	30 (27*)	45 (42*)
E	8	8	10	14	14	18	25
F	16	16	22	32	32	40 (37*)	58 (55*)
G	4	4	6	10	10	10	14
H	5	5	6,5	10	10	10	15

* with eyelets in AISI 303/316L

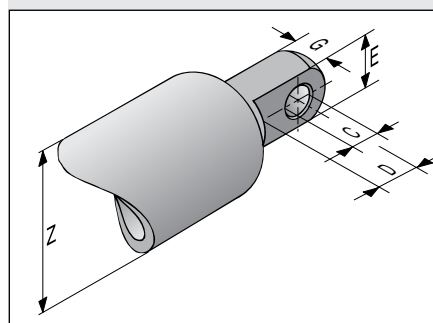

Eyelet on cylinder (A) - pressed into cylinder

	3-10	4-12	6-15	8-19	10-23	14-28	20-40
C	Ø4	Ø4	Ø6	Ø8	Ø8	Ø8	Ø14
D	7	7	9	11	13	16	20
E	8	8	10	14	18	20	32
G	4	4	6	10	10	10	14
Z	Ø10	Ø12	Ø15	Ø19	Ø23	Ø28	Ø40

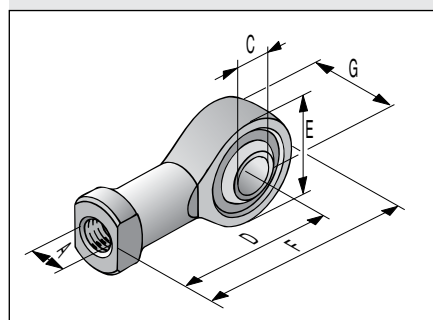

Rose bearing (GK) - for piston rod and cylinder

	6-15	8-19	10-23	14-28	14-28	20-40
Steel	205800	205801	205801	205802	205802S	205803
AISI 303		205811	205811	205812		205806
A	M5	M8	M8	M10	M10	M14x1,5
C	5	8	8	10	10	14
D	27	36	36	43	43	57
E	18	24	24	28	28	36
F	36	48	48	57	57	75
G	8	8	8	14	9	19

Rose bearing (GKV) AISI 303 for 8-19/10-23 gas springs part no. 205811
for 14-28 gas springs part no. 205812

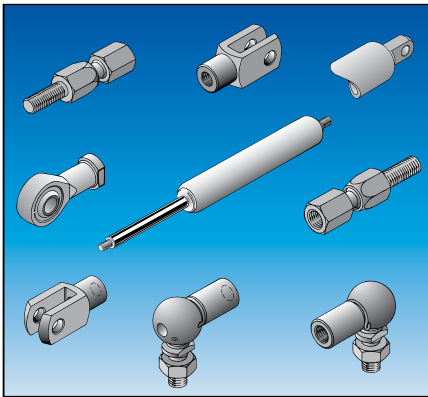

Gas Spring End Fittings Dimensioned Drawings cont.

If you are planning to use the **fork (G)** as an end fitting, we recommend you also use the **ES pin** which makes the fitting quicker and easier. It is simply clipped onto the neck of the fork and saves you having to fasten a pin through a safety ring or key. It is available for all ranges, except 25-55 and 30-65.

If the gas spring **cannot be installed precisely**, you should use a **ball and socket joint** or **inline ball and socket joint** at least on one side. However, you must make sure when installing the gas spring that it does not tilt or twist.

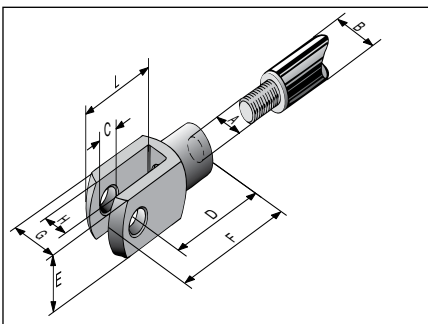

Fork (G) DIN 71752 - for piston rod and cylinder

	3-10	4-12	6-15	8-19	10-23	14-28	20-40	25-55	30-65
A	M3,5	M3,5	M5	M8	M8	M10	M14x1,5	M20x1,5	M24x2
B	Ø3	Ø4	Ø6	Ø8	Ø10	Ø14	Ø20	Ø25	Ø30
C	Ø4	Ø4	Ø5	Ø8	Ø8	Ø10	Ø14	Ø20	Ø25
D	16	16	20	32	32	40	56	80	100
E	8	8	10	16	16	20	27	40	50
F	21	21	26	41	41	52	72	105	132
G	8	8	10	16	16	20	27	40	50
H	4	4	5	8	8	10	14	20	25
L	13	13	16	25	25	32	44		

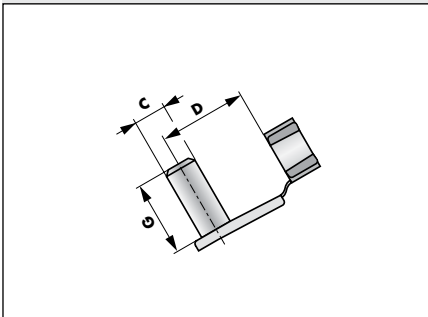

ES-pin for fixing fork

	3-10	4-12	6-15	8-19	10-23	14-28	20-40
C	Ø4	Ø4	Ø5	Ø8	Ø8	Ø10	Ø14
D	11	11	14	22	22	28	38
G	9,5	9,5	12	19	19	23	31

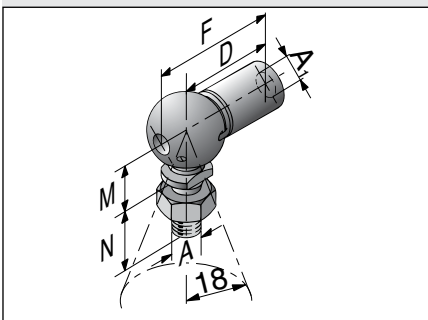

Ball and socket joint (WG) DIN 71802 - for piston rod and cylinder

	3-10	4-12	6-15	8-19	10-23	14-28	20-40
A ₁ /A	M3,5/M4	M3,5/M4	M5	M8	M8	M10	M14x1,5
D	18	18	22	30	30	35	45
F	24	24	28	39	39	46	60
M	9	9	9	13	13	16	20
N	10,3	10,3	10	16	16	19	28

Ball and socket joint (WGK) DIN 71802 - for piston rod and cylinder:

Short type for the diameter ranges 8-19 and 10-23: D = 18 (for all other dimensions see table for the standard type WG) **Maximum pressure 650 N**

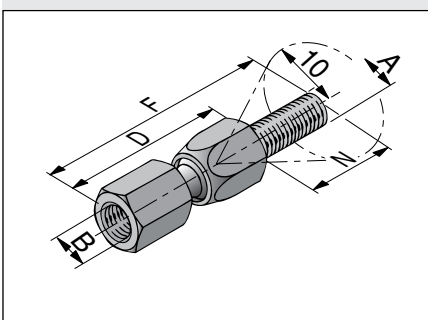

Inline ball and socket joint (KGA) to be screwed on* (not for pulling forces!)

	6-15	8-19	10-23	14-28	20-40
A	M8	M8	M8	M10	M14x1,5
B	M5	M8	M8	M10	M14x1,5
D	28	31	31	43	56
F	63	66	66	68	96
N	35	35	35	25	40

*When ordering a large batch, the ball of the ball and socket joint can be directly threaded onto the piston rod. This reduces the corresponding measurement D. Please ask on request.

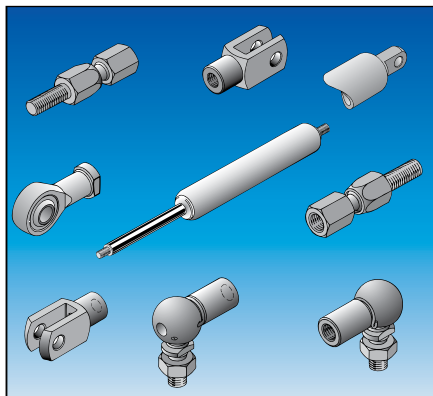

**Gas Spring End Fittings
Dimensioned Drawings** cont.

Two special eyelets are available along with the standard eyelets for the 6-15, 8-19 and 10-23 ranges:

The ALK eyelet can be used when the total length of the gas spring needs to be as short as possible. It is shorter than the normal eyelet.

The ASL eyelet is intended for situations where the seat to which the eyelet needs to be attached is very small. At just 5 mm, it is only half as wide as normal eyelets.

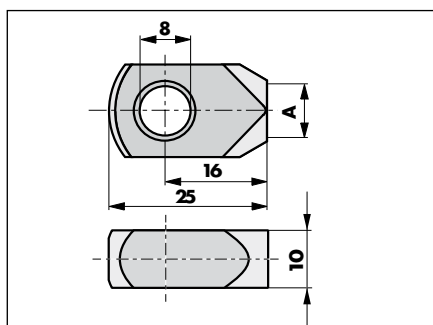

ALK eyelet (short) - to be screwed on

	6-15	8-19/10-23
Part no.	0615ALK	0819ALK
A	M5	M8

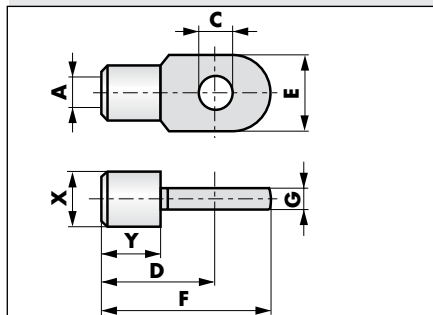

ASL eyelet (slim) - to be screwed on

	6-15	8-19/10-23
Part no.	0615ASL	0819ASL
A	M5	M8
C	Ø6,1	Ø8,1
D	20	30
E	12	18
F	26	39
G	3	5
X	12	13
Y	9	14